

# Vetrex Slide 82

schemat A

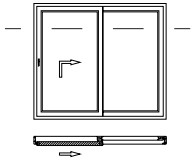

schemat D

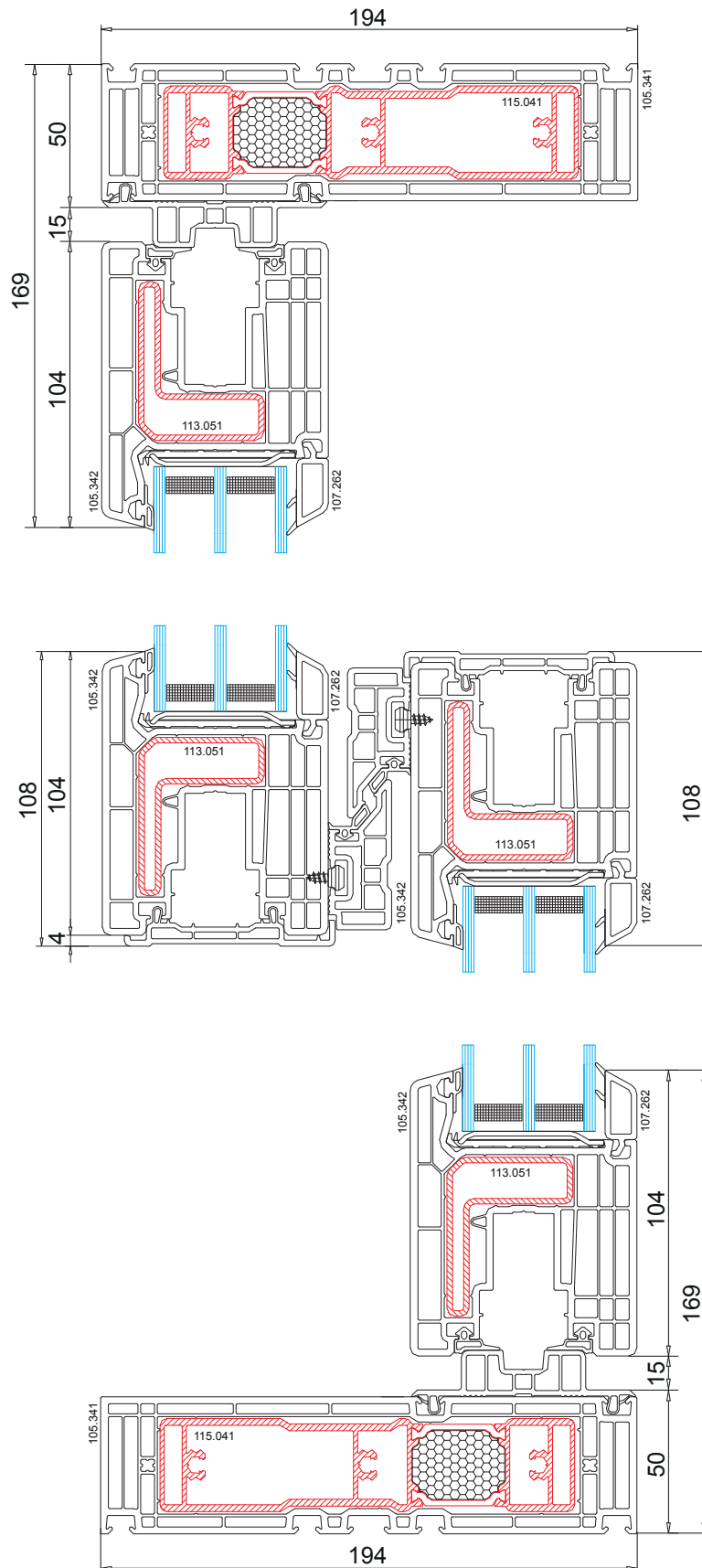
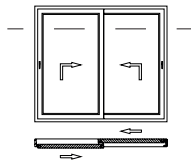

# Vetrex Slide 82

schemat C wariant

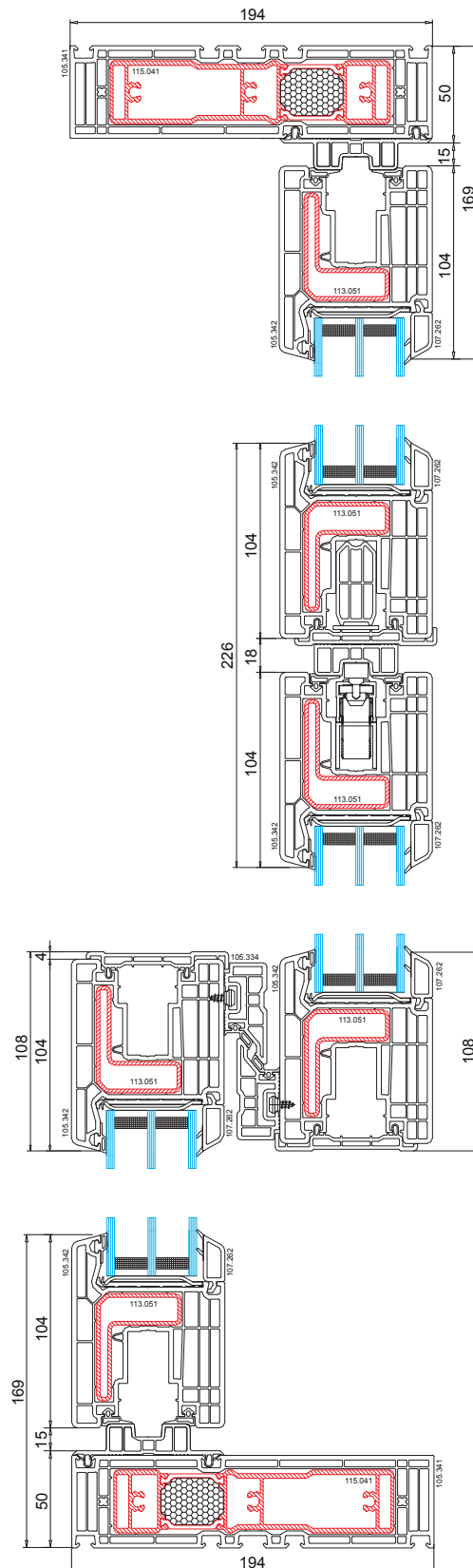
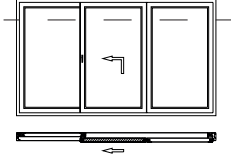

# Vetrex Slide 82

schemat C

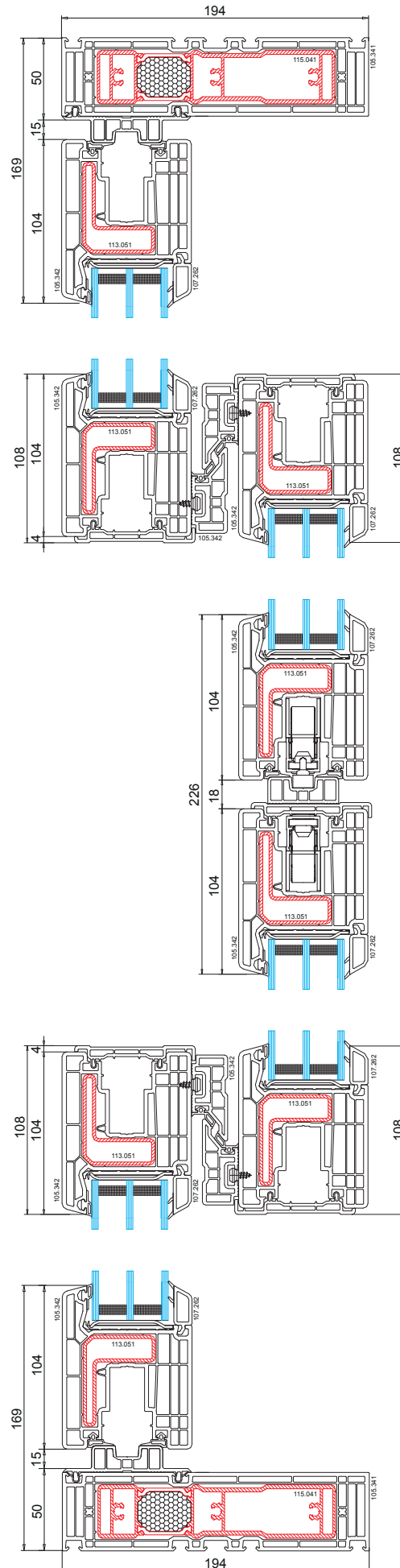
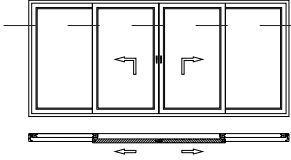

# Vetrex Slide 82

schemat A

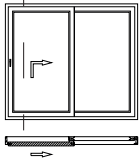

schemat C

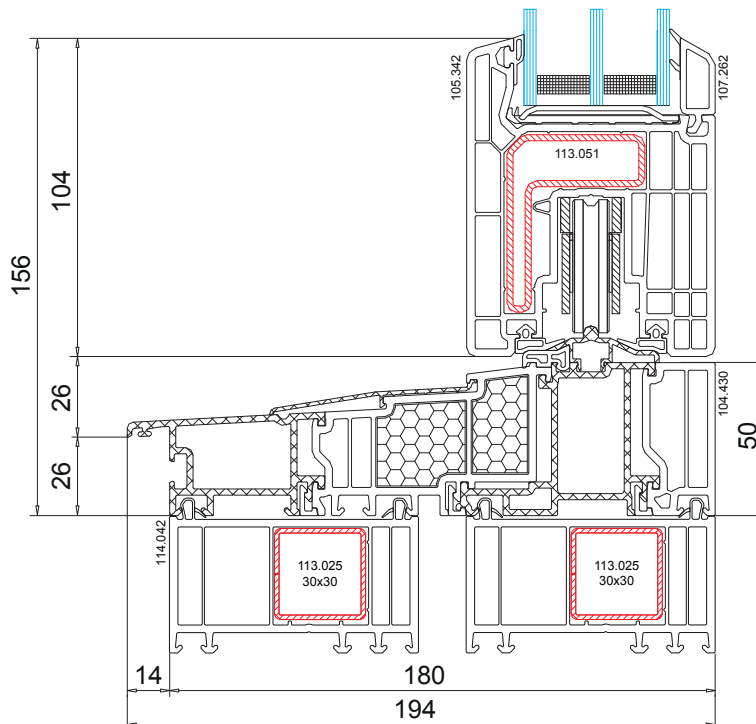
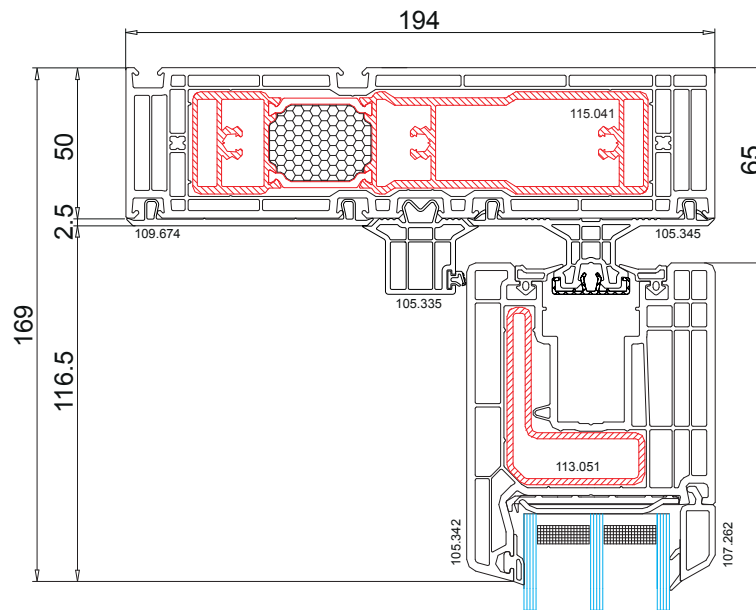
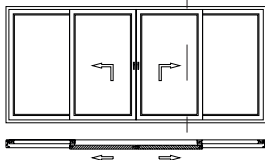

# Vetrex Slide 82

schemat A

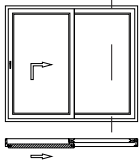

schemat C

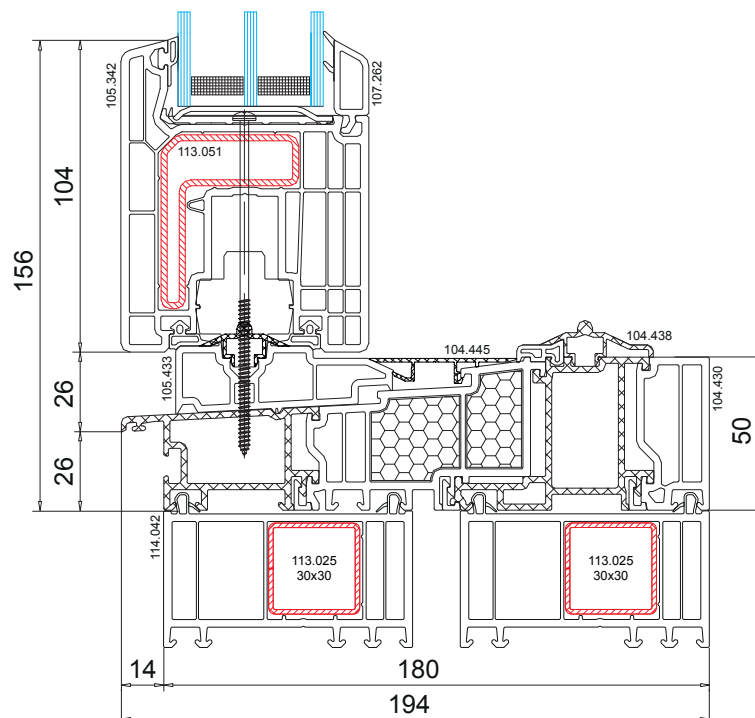
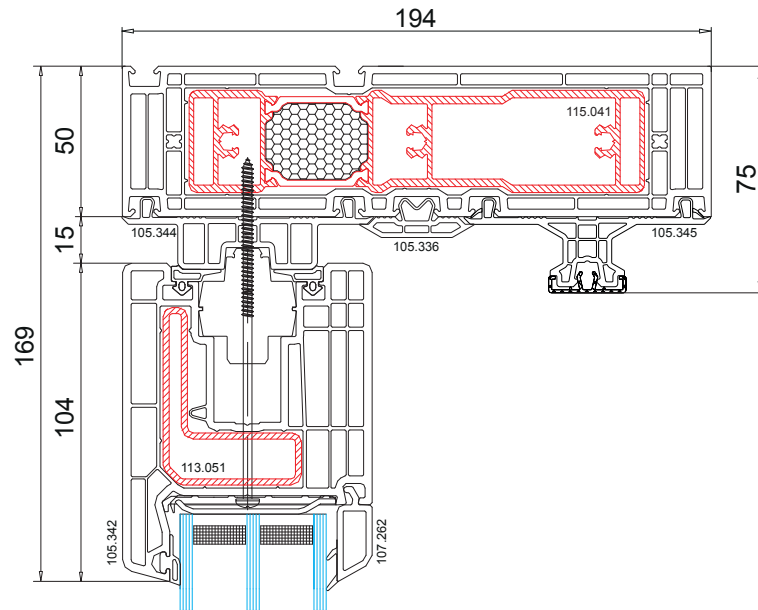
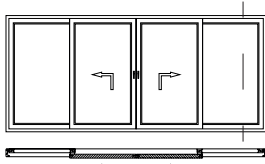

# Vetrex Slide 82

schemat D

